



**YANMAR**

TRUE ZERO TAIL SWING EXCAVATOR

# **Vi080-1**

[Gross] 42.4kW (56.9hp)



\* The machine in the picture is equipped with optional parts.

# Superior cost performance. Excavator suitable for a variety of sites.

Comfortable even when working in confined spaces.

Excellent endurance, strength, and spacious cab make it easy to use and ideal for long working hours. Highly cost-effective.

Experience a construction machine that is reliable and has proven results.





\* Pictures shown are for illustration purpose only. \* The images shown here are for promotional purposes.  
\* The image may differ from the actual model on sale. \* The machine in the picture is equipped with optional parts.  
\* Ground the bucket when leaving the operator's seat.





# Details of Vi080-1

## Features

Advanced 8 t class  
excavator in the  
Mini-Concept family

The boom cylinder guard prevents  
damage caused by contact.

►Page 8

A spacious cabin

►Page 11

Compliance with international  
safety standards.  
ROPS/OPG<sup>1</sup> top guard (level I)  
compliant cabin + retractable  
seatbelt provided as standard part.

►Page 9

Boom swing provided  
as a standard part,  
allowing you to work up  
close to structures.

►Page 7

Boom light is installed inside  
the structure to protect it  
from damage

►Page 9

External engine shut-off switch to stop the  
engine in case of emergency

►Page 9







Back-mirror provided as a standard part for checking the rear side of the excavator.

▶Page 8



The right hood can be opened without using any tools, thus allowing easy checking and cleaning of parts.

▶Page 12

The pressed steel hood is sturdy and allows easy access for repairs.

▶Page 8

True Zero Tail Swing allows a smooth swing even in confined spaces.

▶Page 6

Underside protector reduces hood damage.

▶Page 9

\*1 ROPS: Roll-Over Protective Structure (A structure to protect the operator wearing a seat belt, in case the machine rolls over)

OPG top guard: Operator Protective Guards.\* The images shown here are for promotional purposes.

\* The image may differ from the actual model on sale.

\* The machine in the picture is equipped with optional parts. \* Ground the bucket when leaving the operator's seat.

# The flat body of the excavator ensures work efficiency and safety.

A flat back takes care of safety, stability, and work efficiency during swing operations when performing work on various types of sites. Equipped with a standard boom swing, the excavator is perfect for ditch excavation along walls and works efficiently in confined spaces as well.

## The rear of the cabin does not protrude, ensuring smooth and safe turns.

### ● True Zero Tail Swing

Works efficiently and can be operated without worrying about the tail swing. The excavator body stays within the machine width. This helps reduce the operator's efforts and work time.

### ● Excellent turning ability in the front

During gutter excavation, boom swings remain within the width of the machine from the boom bracket downwards.

**No overhang**

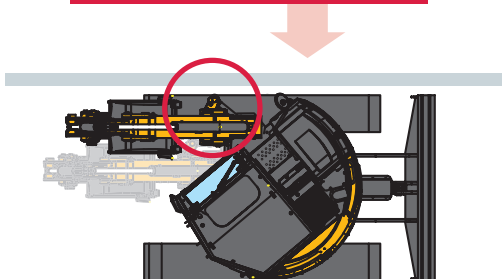



# Features a powerful, fuel-efficient, and Eco-friendly engine

## ● Cooled-EGR

Reduced Nox emissions by Exhaust Gas Recirculation



The Exhaust Gas Recirculation (EGR) system partially cools the exhaust gas, and by mixing it with suction air and circulating it within the cylinder, lower the burning temperature inside the cylinder and decrease nitric oxide (NOx). The EGR valve controls the circulating amount of EGR depending on the density of intake oxygen, which in turn depends on the suction temperature and altitude. It allows a stable combustion control of fuel under all working conditions.

## ● Direct fuel injection system

Achieved low emission with high burning efficiency



Engine model  
**4TNV98**  
Engine output (gross)  
**42.4kW**

\* Picture of engine shown for illustration purpose only.

## ● Eco-mode function

Reduces fuel consumption by reducing the maximum engine speed by approximately 10%.



## ● Auto deceleration

If the operation lever stays in neutral for more than 4 seconds, the engine speed will automatically change to low idle. The engine speed will automatically revert to the original speed once the operation lever is moved.



## ● Fuel efficiency

An excellent hydraulic system combined with the Eco mode and Auto deceleration functions makes it the most fuel efficient excavator in its class.

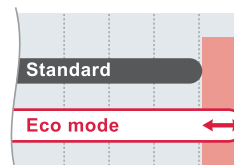

**9%**  
**INCREASE**

# Equipped with a standard 8 t class boom swing.

Capable of digging right next to walls.

## ● Boom swing

The excavator is equipped with a standard boom swing. As the boom can swing up to 60 degrees on both sides, the excavator faces the work area when digging a ditch, thus increasing the work efficiency.

Min. swing radius  
**2470 mm**

Min. boom swing radius  
**2130 mm**

Tail swing radius  
**1135 mm**

Blade width  
**2270 mm**



\*without Quick coupler

\* The images shown here are for promotional purposes. \* The image may differ from the actual model on sale.  
\* The machine in the picture is equipped with optional parts. \* Ground the bucket when leaving the operator's seat.

# Satisfying implements make the work reliable

- **Boom cylinder guard**



Guards the boom cylinder from damage or scratches

- **The cabin design offers superb rear visibility and the standard back mirror further improves on this**



Provides a sufficient visibility of the area near the rear end of the excavator, ensuring safety even during repeated forward or backward movement of the excavator.

- **Automatic high speed when running**

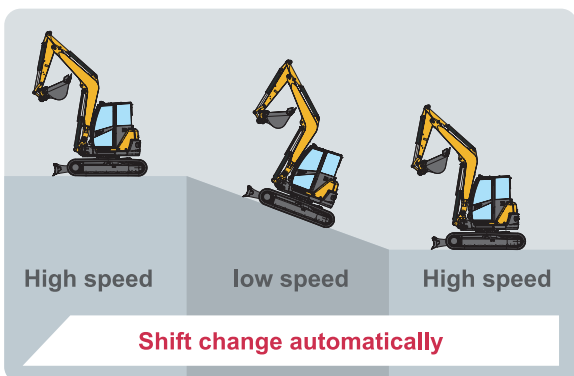

Change the speed automatically depending on the load so that the machine can always run with power.



- **Pressed steel hood**

Adopt a hood made of steel plate with excellent durability and easy to repair when damaged.







● **Cabin light + Built in boom light**



The 3 front lights enable the operator to see clearly at night or at work places with insufficient light.

● **Equipped with standard ROPS/OPG top guard (level I) compliant cabin + retractable seatbelt**



**ROPS (Roll-Over Protective Structure)**

A structure to protect the operator wearing a seat belt, in case the machine rolls over.

**OPG top guard (level I) (Operator Protective Guards)**

A structure to protect the operator from falling objects.

● **External engine shut-off switch**

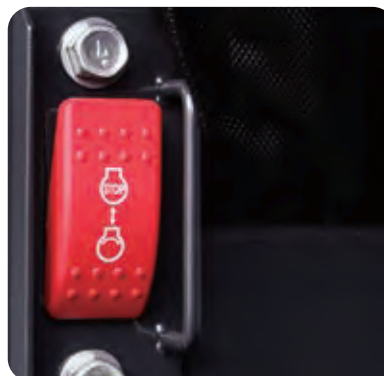

In an emergency, this switch immediately stops the engine with one-touch.

● **Underside protector**

Made the cover thicker to strengthen the bonnet cover and decrease damage.



\* The images shown here are for promotional purposes. \* The image may differ from the actual model on sale.

\* The machine in the picture is equipped with optional parts. \* Ground the bucket when leaving the operator's seat.

# Creates an agreeable work space for maximum operating comfort

● Two-speed automatic



● Eco mode switch



● Auto deceleration switch



● The large LCD display includes an LED backlight, that makes it enable for the operator to easily check information in the low light conditions.

Easy to find out essential information related to operational status and errors, by an easy to read monitor, LED indicator lamps and buzzer.

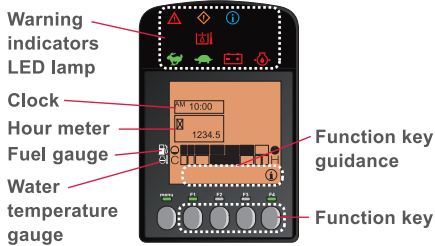

LCD monitor display examples

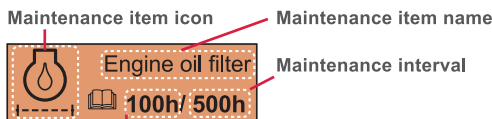

LCD monitor sample screen

1months operation time is displayed\*

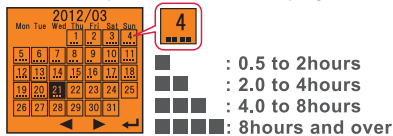

Displays up to 3months\*



\* Daily operation hours separated by AM/PM

● Air recirculation type air conditioner



Maintains optimum cabin temperature at all times. Maintains a comfortable temperature inside the cab by optimal air flow and intake of fresh outside air.







● **Double slide seat and retractable seat belt**



The position of the lever and seat can be adjusted to achieve maximum driving comfort. A retractable, hence, easy-to-fix seat belt.

(The ROPS protective structure works only if the operator is wearing a seat belt.)

● **Box**



● **Wrist control levers + adjustable arm rests.**

Wrist control lever are easy to grasp, and arm rests can be repositioned to meet the operator's preferences and work posture, reducing fatigue even after long hours of operation.



● **A multitude of convenient functions and features to raise your work efficiency.**



Front window washer



Accelerator dial



Evacuation hammer



Radio antenna + Connection harness



External power outlet



Ashtray



Drink holder

\* The image may differ from the actual model on sale. \* The machine in the picture is equipped with optional parts.

# Easy access for efficient maintenance.

## ● Rear hood

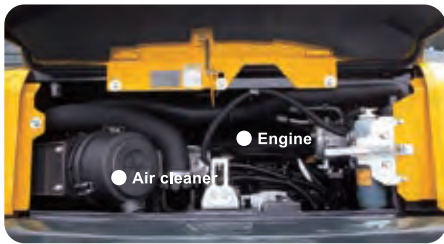

Can be removed without tools, making inspection/maintenance of the engine area and air cleaner simple.

## ● Front cover (right)

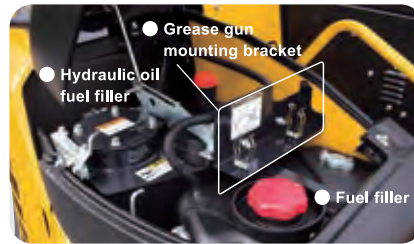

Allows an easy supply of fuel and hydraulic fluid, cleaning of the rear part of the radiator, and lubrication of parts with a grease gun.

## ● Right hood

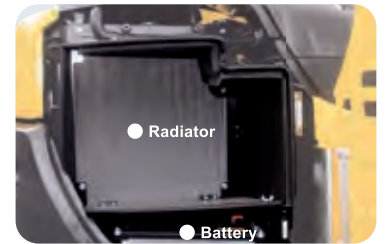

No tools are needed to open the right-hand hood, making battery inspections and cleaning the radiator an easy task.



## ● Inspection window for fan belt and A/C belt



Large inspection window for easy access.



## ● Cab air conditioner filter

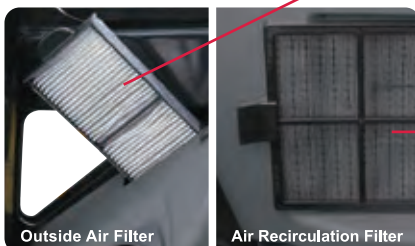

Can be removed, cleaned, and replaced without using any tools.



## ● Tool compartment



Can be used for storing teeth bars, etc.



# A wide variety of functions for various types of sites and work.

\*These functions differ depending on the region, Please contact your YANMAR dealer for further information.

## ● P.T.O. specification

**Model using P.T.O.1 (VAE) [with flow regulation]**  
Supports various types of attachments.

**Model using P.T.O.2 (VAE) [with flow regulation]**  
Supports the attachments requiring a dual control system not supported by P.T.O.1.



**P.T.O.1**  
**P.T.O.2**

\* Pictures shown are for illustration purpose only.

**P.T.O.1 switch**  
Move the switch horizontally to operate the attachments connected to P.T.O.1 circuit.



**P.T.O.2 switch**  
Move the switch horizontally to operate the attachments connected to P.T.O.2 circuit.



Both P.T.O.1 and P.T.O.2 allow flow regulation by turning the dial.



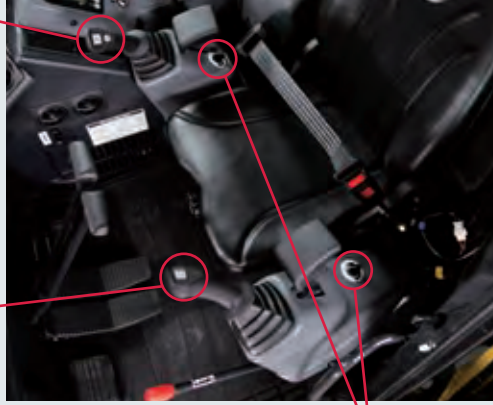

\* [Models using P.T.O.]VAE : Attachment pipe on the arm end

## Important attachments

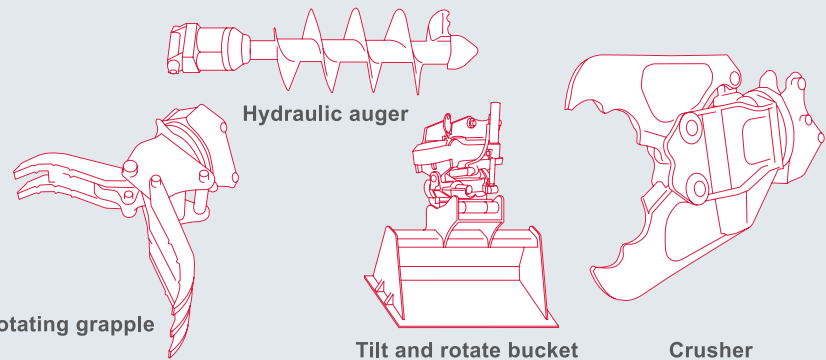

Rotating grapple      Hydraulic auger      Tilt and rotate bucket      Crusher

## ● Increased weight







## ● Pattern change valve (2way/4way)

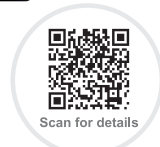

## ● Hydraulic quick coupler makes changing attachments quick and easy.



### ● Unattach bucket

Place the bucket on the ground.      Pull out the safety lock pin.      Turn the switch to Remove.      Raise the arm to detach.

### ● Attach bucket





Hang the fixed hook.      Level the bucket.      Turn the switch to Attach.      Insert the safety lock pin and fasten.

\* The images shown here are for promotional purposes. \* The image may differ from the actual model on sale.

\* The machine in the picture is equipped with optional parts. \* Ground the bucket when leaving the operator's seat.



● **Efficient use of machinery thanks to remote monitoring**

Our construction equipment is equipped with GPS and communication terminals, allowing you to manage location information via the communication system. The system also lets YANMAR remotely monitor your machine, allowing us to keep on top of maintenance intervals, quickly identify machine trouble, and provide appropriate services and support at all times.



● **Providing peace of mind, supporting your business**

**Thft prevention tool**  
The theft prevention feature emails you if the machine moves out of a pre-determined area.

**Error notification service**  
Quickly identify location of error in the event of machine trouble.\*

**Maintenance management tool**  
Manage inspection/maintenance information.

**Operational status management tool**  
Visualize operational status of machine.

**Work schedule creation tool**  
Record work data and improve efficiency.

\* The contents displayed on the screen may differ.

## The Unsung Heroes Who Build Our Towns And Cities

You build the infrastructure and the foundations in our towns and cities.  
Transforming the places where we stand today, into dreams of tomorrow.  
You are the unsung hero.

The YANMAR mission is to provide machines and services that allow you to reach your full potential.

Built tough and with comfort in mind,  
YANMAR construction equipment will help you get the job done with ease, regardless of the worksite.  
When we make machines, we are dedicated to enabling you to perform at your best all of the time.

One example of this is our innovative True Zero Tail Swing Excavators that set the standard for safety and reliability, enabling operators to perform at their best in tight quarters.

YANMAR also manufactured the first compact diesel engines and today we continue to make diesel engines ranging from 4 to 4,800 kW.

Equipped with advanced engines and hydraulic systems, our construction equipment delivers better fuel economy, increased productivity and enhanced operation.

**YANMAR is the driving force behind the unsung hero.**

**BEST PERFORMANCE BY YOUR SIDE**



# Lifting Capacity

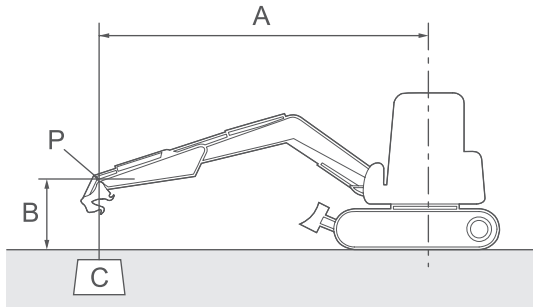

With;  
Cabin  
Rubber Crawler  
Quick coupler spec.  
Without Bucket

A: Reach from swing center line [m<in.>]

B: Load point height [m<in.>]

C: Lifting load [kg<lbs.>]

P: Load point

: Rating over front

: Rating over side or 180 degrees

## Blade on ground

Unit : kg (lbs.)

A [m<in.>]	Max.		5.0<196.9>		4.0<157.1>		3.0<118.1>	
B [m<in.>]								
5.0<196.9>	1650 <*3638>	1240 <2734>	-	-	1620 <*3572>	1610 <*3550>	-	-
4.0<157.5>	1550 <*3417>	1040 <2293>	1550 <*3417>	1160 <2557>	1620 <*3572>	1600 <*3528>	-	-
3.0<118.1>	1580 <*3483>	890 <1962>	1640 <*3616>	1140 <2513>	1920 <*4233>	1890 <*4167>	2480 <*5468>	2500 <*5512>
2.0<78.7>	1520 <*3351>	790 <1741>	1790 <*3946>	1080 <2381>	2280 <*5027>	1850 <*4079>	3120 <*6879>	2580 <*5688>
1.0<39.4>	1540 <*3395>	770 <1697>	1930 <*4255>	1040 <2293>	2590 <*5710>	1720 <*3792>	3470 <*7651>	2300 <*5071>
0<0>	1530 <*3373>	790 <1741>	1960 <*4321>	1010 <2227>	2660 <*5865>	1690 <*3726>	3660 <*8070>	2410 <*5314>
-1.0<-39.4>	1510 <*3329>	890 <1962>	1840 <*4057>	1010 <2227>	2480 <*5468>	1670 <*3682>	3440 <*7585>	2550 <*5622>
-2.0<-78.7>	1350 <*2976>	1090 <2403>	-	-	2040 <*4498>	1700 <*3748>	2820 <*6218>	2690 <*5931>

## Blade above ground

Unit : kg (lbs.)

A [m<in.>]	Max.		5.0<196.9>		4.0<157.1>		3.0<118.1>	
B [m<in.>]								
5.0<196.9>	1610 <*3550>	1240 <2734>	-	-	1570 <*3461>	1610 <*3550>	-	-
4.0<157.5>	1090 <2403>	1030 <2271>	1240 <2734>	1130 <2491>	1550 <*3417>	1600 <*3528>	-	-
3.0<118.1>	920 <2028>	860 <1896>	1210 <2668>	1110 <2447>	1870 <*4123>	1880 <*4145>	2420 <*5336>	2510 <*5534>
2.0<78.7>	830 <1830>	770 <1697>	1140 <2513>	1050 <2315>	1630 <3594>	1540 <3395>	2800 <*6174>	2180 <4806>
1.0<39.4>	800 <1764>	760 <1675>	1080 <2381>	1020 <2249>	1560 <3439>	1440 <3175>	2070 <4564>	1930 <4255>
0<0>	830 <1830>	780 <1719>	1060 <2337>	980 <2160>	1500 <3307>	1430 <3153>	2210 <4873>	2060 <4542>
-1.0<-39.4>	920 <2028>	870 <1918>	1050 <2315>	980 <2160>	1490 <3285>	1400 <3087>	2330 <5137>	2120 <4674>
-2.0<-78.7>	1130 <2491>	1100 <2425>	-	-	1530 <3373>	1450 <3197>	2400 <5292>	2250 <4961>

### Note :

The lifting load with the asterisk (\*) mark is limited by hydraulic lifting capacity rather than tipping. The lifting capacity shown in the above list is based on the ISO Standard No. 10567 and represents either 87 % of hydraulic lifting capacity or 75 % of tipping load, which is smaller.

● Dimensions

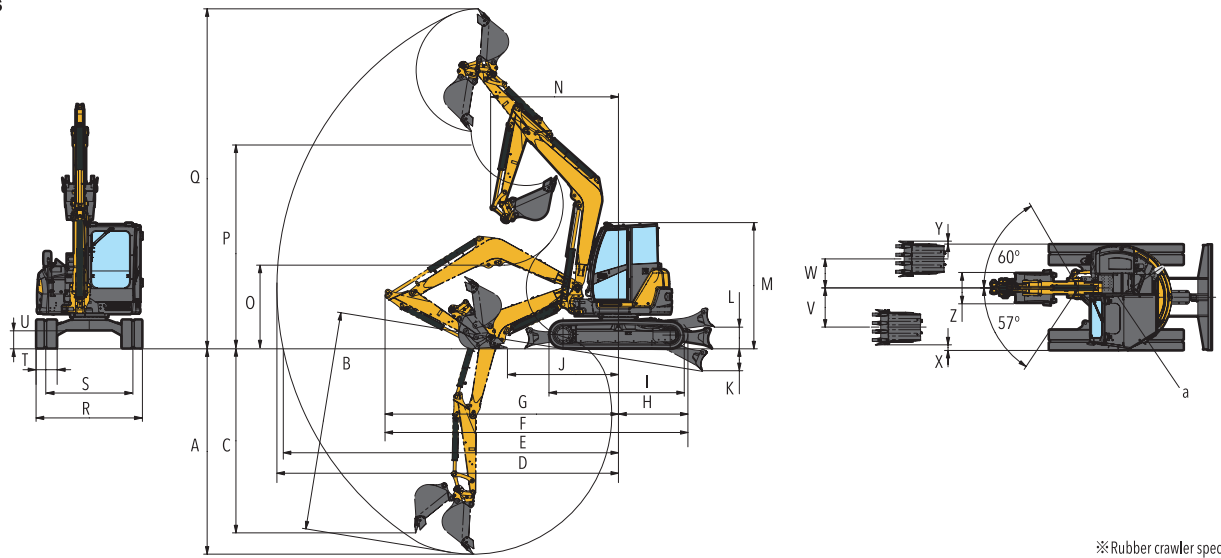

※Rubber crawler specification

Unit : mm (ft-in)

		A	B	C	D	E	F	G	H	I	J	K	L	M	N	O	P	Q	R	S	T	U	V	W	X	Y	Z	a			
ViO80-1	Quick Coupler	4400 (14'5")	4680 (15'4")	3940 (12'11")	7280 (23'11")	7140 (23'5")	6460 (21'2")	4970 (16'4")			2380 (7'9")				2710 (8'11") R2730 (7'9") at boom swing	1750 (5'7")	4620 (15'2")	7230 (23'9")													
	without Quick Coupler	4150 (13'7")	4440 (14'7")	3800 (12'6")	6960 (22'10")	6820 (22'5")	6410 (21'0")	4930 (16'2")	1990 (6'6")	2890 (9'6")	2270 (7'5")	480 (1'7")	460 (1'6")	2680 (8'10")	2470 (8'1") R2130 (6'12") at boom swing	1940 (6'4")	4680 (15'4")	6790 (22'3")	2270 (7'5")	1870 (6'2")	450 (1'6")	390 (1'3")	840 (2'9")	620 (2'0")	120 (0'5")	60 (0'2")	750 (2'6")	1135 (3'9")			

Specifications

Model		ViO80-1			
Spec		Cab. rubber crawler		Cab. steel crawler	
Type		Quick coupler	without Quick coupler	Quick coupler	without Quick coupler
Operating Weight		kg (lbs)			
		8225 (18136)	8065 (17783)	8285 (18268)	8125 (17916)
Engine	Type	Vertical 4 cylinder, water-cooled direct injection diesel			
	Model	YANMAR 4TNV98-ZWBV2			
	Rated Output	kW (hp) / min-i			
	Maximum output at high idle speed(Gross)	kW (hp) / min-i			
Performance	Bucket capacity, standard (ISO heaped)	cu.m (cu.ft)			
		0.28 (9.89)			
	Max Digging Force, Bucket / Arm	kN (lbf)		kN (lbf)	
		50.4 (11330) / 37.2 (8683)	63.5 (14275) / 40.8 (9172)	50.4 (11330) / 37.2 (8683)	63.5 (14275) / 40.8 (9172)
	Traveling Speed, High / Low	km / h (MPH)		km / h (MPH)	
		4.5 (2.8) / 2.5 (1.6)		4.1 (2.5) / 2.3 (1.4)	
	Swing Speed	RPM			
		9.0			
	Boom Swing Angle, (L / R)	degrees			
		57 / 60			
	Gradability	degrees			
		30			
Ground Contact Pressure		kPa (PSI)			
		35.8 (5.19)	35.1 (5.09)	36.2 (5.25)	35.5 (5.15)
Hydraulic System	Pump Capacity	L / min (GPM)			
		70.3 (18.6) x2, 53.2 (14.1) x1 (Variable displacement pump) 19 (5.0) x1 (Gear pump)			
	Main Relief Set Pressure	MPa (PSI)			
		25.5x2, 24.0x1, 2.9x1 (3698x2, 3481x1, 421x1)			
Blade	Width	mm (ft-in)			
		2260 (7'5")			
Dimensions	Stroke, Raise / Lower from G.L.	mm (ft-in)		mm (ft-in)	
		460 (1'6") / 480 (1'7")		440 (1'5") / 500 (1'8")	
Fuel tank capacity		L (Gals)			
		115 (30.4)			

Hydraulic P.T.O.

Model		ViO80-1	
Output		L / min (GPM)	
Specification		MPa (PSI)	
Combined Flow, Double Actions		1900RPM	1200RPM
		25.5 (3698)	120 (31.7) / 75 (19.8)

All data subject to change without notice.