



**YANMAR**

ULTRA TIGHT TURNING EXCAVATOR

# **SV100-2B**

[Gross] 54.7kW <73.3hp>



\* The machine in the picture is equipped with optional parts.

# 10 t class + mini concept. A machine dedicated to usability.

Equipped with a standard 10 t class boom swing and blade, the SV100-2B caters to a variety of needs from different types of work sites, exhibiting superior operability, durability, safety, and an eco-friendly design. SV100 offers ultra-tight turning for excellent usability and it can also be transported using a 10 t truck.

\* Mini concept is a product equipped with a boom swing and blade.





**YANMAR**

\* Pictures shown are for illustration purpose only. \* The images shown here are for promotional purposes.  
\* The image may differ from the actual model on sale.  
\* The machine in the picture is equipped with optional parts.  
\* Ground the bucket when leaving the operator's seat.

# Details of SV100-2B

## Features

Advanced 10t class excavator  
in the Mini-Concept family

The boom cylinder guard prevents  
damage caused by contact.

►Page 9

A wide operation space

►Page 11

Compliance with international  
safety standards.  
ROPS/OPG<sup>1</sup> top guard (level I)  
compliant cabin + retractable  
seatbelt equipped as standard.

►Page 8

Boom swing equipped  
as standard,  
allowing you to work up  
close to structures.

►Page 7

The light weight and compact size of the excavator  
enable it to be transported in a 10 t loading truck.

►Page 7

Work in comfort even at night  
with the cabin light + boom light

►Page 9

External engine shut-off switch to stop the  
engine in case of emergency

►Page 9





Back-mirror provided as a standard part for checking the rear side of the excavator.

▶Page 8

The right hood can be opened without using any tools, thus allowing easy checking and cleaning of parts.

▶Page 12

The pressed steel hood is sturdy and allows easy access for repairs.

▶Page 8

The ultra-tight turning of the excavator enables it to be used even in confined spaces.

▶Page 6

Underside protector reduces bonnet damage.

▶Page 9

\*1 ROPS: Roll-Over Protective Structure (A structure to protect the operator wearing a seat belt, in case the machine rolls over)  
OPG top guard: Operator Protective Guards.

\*The images shown here are for promotional purposes. \* The image may differ from the actual model on sale.

\*The machine in the picture is equipped with optional parts. \* Ground the bucket when leaving the operator's seat.

# Boasts of high usability, and demonstrates it on a variety of work sites.

The compact size that can access to all kinds of worksites, plus the functions and implements makes the operations safe and smooth in narrow places.

These little things make a big difference in the improvement of work quality.

## Able to swing safely and smoothly with less protrusion from the crawler.

### ● Ultra-tight turning

Protrusion from the rear crawler being small, the excavator is suitable for working in confined spaces and on various types of work sites.

### ● Excellent turning ability in the front

During gutter excavation, boom swings remain within the width of the machine from the boom bracket downwards.

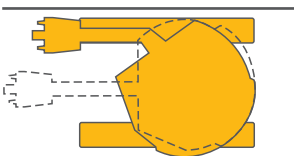

Crawler protrusion amount

**170 mm**

Blade width

**2320 mm**



# Features a powerful, fuel-efficient, and Eco-friendly engine.

## ● Cooled-EGR

Reduced Nox emissions by Exhaust Gas Recirculation



The Exhaust Gas Recirculation (EGR) system partially cools the exhaust gas, and by mixing it with suction air and circulating it within the cylinder, lower the burning temperature inside the cylinder and decrease nitric oxide (NOx). The EGR valve controls the circulating amount of EGR depending on the density of intake oxygen, which in turn depends on the suction temperature and altitude. It allows a stable combustion control of fuel under all working conditions.

## ● Direct fuel injection system

Achieved low emission with high burning efficiency



Engine model  
**4TNV98T-ZSBV2**  
Engine output (Gross)  
**54.7kW**

\* Picture of engine shown for illustration purpose only.

## Fuel efficiency

An excellent hydraulic system combined with the Eco mode and Auto deceleration functions makes it the most fuel efficient excavator in its class.



## Eco-mode function

Reduces fuel consumption by reducing the maximum engine speed by approximately 10%.



## Auto deceleration

If the operation lever stays in neutral for more than 4 seconds, the engine speed will automatically change to low idle. The engine speed will automatically revert to the original speed once the operation lever is moved.



# The compact size of the excavator enables it to be transported in a 10t loading truck.

Total height  
**2810 mm**

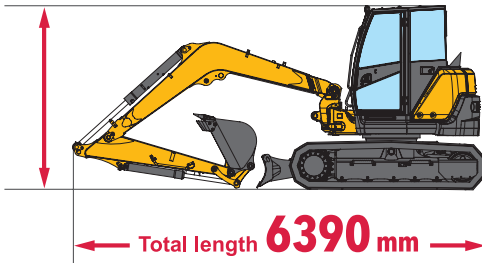

Total length **6390 mm**

\* Models with Quick-Coupler

Total width  
**2320 mm**

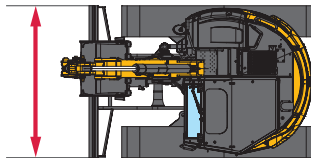

Operating mass (models with steel crawler)

**9630 kg**

\* Rubber pad is not included.

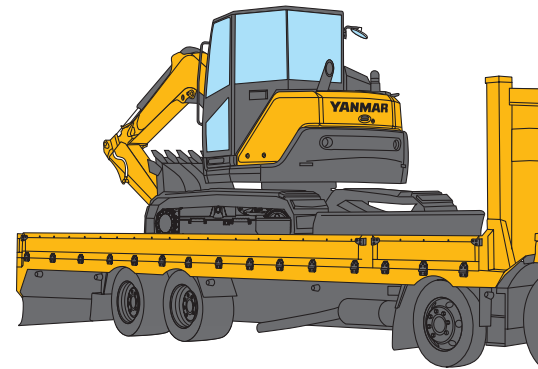

# Equipped with a standard 10t class boom swing.

Capable of digging right next to walls.

## ● Boom swing

The excavator is equipped with a standard boom swing. As the boom can swing up to 60 degrees on both sides, the excavator faces the work area when digging a ditch, thus increasing the work efficiency.

Front minimum swing radius  
**2480 mm**

Boom swing angle  
On both left and right **60°**

Tail swing radius  
**1330 mm**

Front minimum swing radius (when swinging)  
**2110 mm**

Blade width  
**2320 mm**



\* The images shown here are for promotional purposes.  
\* The image may differ from the actual model on sale.  
\* The machine in the picture is equipped with optional parts.  
\* Ground the bucket when leaving the operator's seat.

# Satisfying implements make the work reliable

- The cabin design offers superb rear visibility and the standard back mirror further improves on this

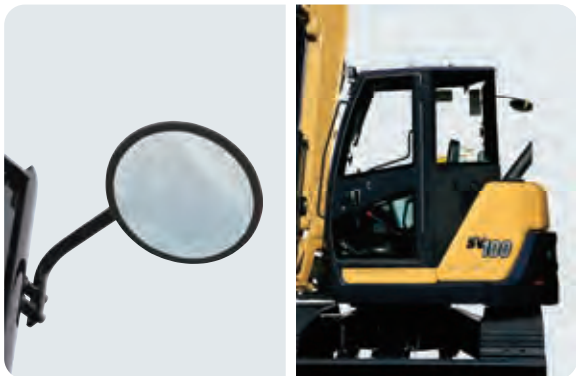

Provides a sufficient visibility of the area near the rear end of the excavator, ensuring safety even during repeated forward or backward movement of the excavator.

- Equipped with standard ROPS/OPG\*1 top guard (level I) compliant cabin + retractable seatbelt

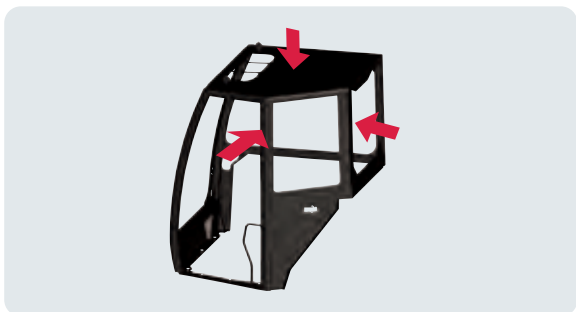

- Automatic high speed when running

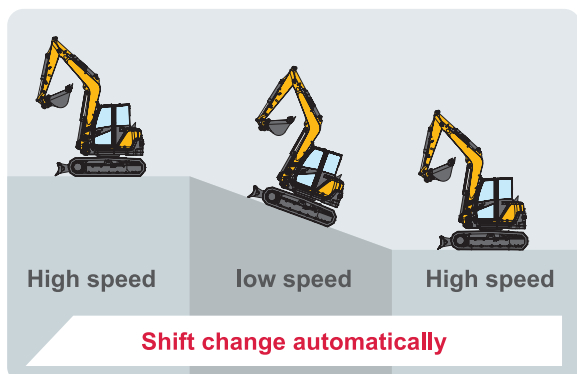

Change the speed automatically depending on the load so that the machine can always run with power.

- Durable steel hood

Adopt a hood made of steel plate with excellent durability and easy to repair when damaged.







● Cabin light + Built in boom light



The 3 front lights enable the operator to see clearly at night or at work places with insufficient light.

● Boom cylinder guard



Guards the boom cylinder from damage or scratches.



● Underside protector

Made the cover thicker to strengthen the bonnet cover and decrease damage.



● External engine shut-off switch



In an emergency, this switch immediately stops the engine with one-touch.

\*1. ROPS: Roll-Over Protective Structure(A structure to protect the operator wearing a seat belt, in case the machine rolls over)

OPG top guard: Operator Protective Guards(A structure to protect the operator from falling objects.)

\* The images shown here are for promotional purposes. \* The image may differ from the actual model on sale.

\* The machine in the picture is equipped with optional parts. \* Ground the bucket when leaving the operator's seat.

# Creates an agreeable work space for maximum operating comfort

1 Two-speed automatic



2 Eco mode switch



3 Auto deceleration switch



The large LCD display includes an LED backlight, that makes it enable for the operator to easily check information in the low light conditions.

Easy to find out essential information related to operational status and errors, by an easy to read monitor, LED indicator lamps and buzzer.

1 LED lamp blinks when displaying warning and information.

2 Clock

3 Hour meter

4 Fuel gauge

5 Water temperature meter

6 F1-F4 lights

7 Switch to select menus/main menu

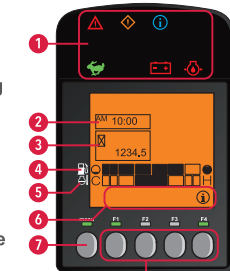

8 F1-F4 perform the operation displayed in guidance



## LCD monitor sample screen

1months operation time is displayed\*



■ : 0.5 to 2hours  
 ■■ : 2.0 to 4hours  
 ■■■ : 4.0 to 8hours  
 ■■■■ : 8hours and over



Displays up to 3months\*

\* Daily operation hours separated by AM/PM

Air recirculation type air conditioner



Maintains a comfortable temperature inside the cab by optimal air flow and intake of fresh outside air.



Drink holder

● **Double slide seat and retractable seat belt**



The position of the lever and seat can be adjusted to achieve maximum driving comfort. A retractable, hence, easy-to-fix seat belt.

(The ROPS protective structure works only if the operator is wearing a seat belt.)

● **Box**



● **Wrist control levers + adjustable arm rests.**

Wrist control lever are easy to grasp, and arm rests can be repositioned to meet the operator's preferences and work posture, reducing fatigue even after long hours of operation.



● **By providing enough space for the operations, its spacious cab keeps the driver's operating efforts to minimum even when working for long hours.**

● **A multitude of convenient functions and features to raise your work efficiency.**



Front window washer



Accelerator dial



Evacuation hammer



Radio antenna + Connection harness

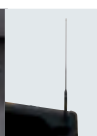

External power outlet



Ashtray



Drink holder

\* The image may differ from the actual model on sale. \* The machine in the picture is equipped with optional parts.

# Easy access for efficient maintenance.

## ● Rear hood

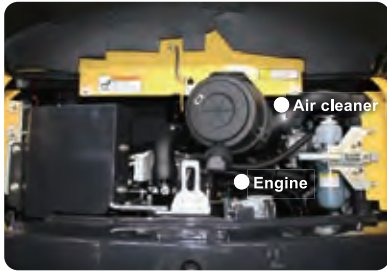

Can be removed without tools, making inspection/maintenance of the engine area and air cleaner simple.

## ● Front cover (right)

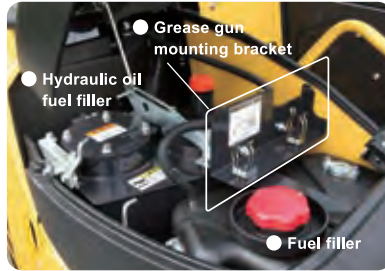

Allows an easy supply of fuel and hydraulic fluid, cleaning of the rear part of the radiator, and lubrication of parts with a grease gun.

## ● Right hood

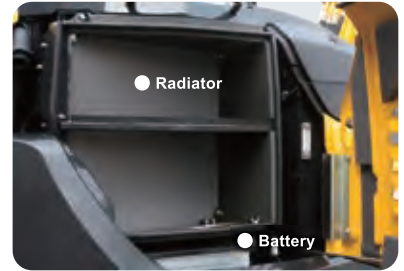

No tools are needed to open the right-side hood, making battery inspections and cleaning the radiator an easy task.



## ● Inspection window for fan belt and A/C belt



Large inspection window for easy access.



## ● Cab air conditioner filter

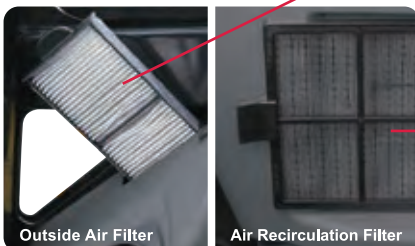

Can be removed, cleaned, and replaced without using any tools.



## ● Tool compartment



Can be used for storing teethbars, etc.

# A wide variety of functions for various types of sites and work.

\*These functions differs depending on the region. Please contact your YANMAR dealer for further information.

## ● P.T.O. specification

**Model using P.T.O.1 (VAE) [with flow regulation]** Supports various types of attachments.

**Model using P.T.O.2 (VAE) [with flow regulation]** Supports the attachments requiring a dual control system not supported by P.T.O.1.



**P.T.O.1**  
**P.T.O.2**

\* Pictures shown are for illustration purpose only.

**P.T.O.1 switch**

Move the switch horizontally to operate the attachments connected to P.T.O.1 circuit.



**P.T.O.2 switch**

Move the switch horizontally to operate the attachments connected to P.T.O.2 circuit.



**Both P.T.O.1 and P.T.O.2 allow flow regulation by turning the dial.**





\* [Models using P.T.O.]VAE : Attachment pipe on the arm end

## Important attachments

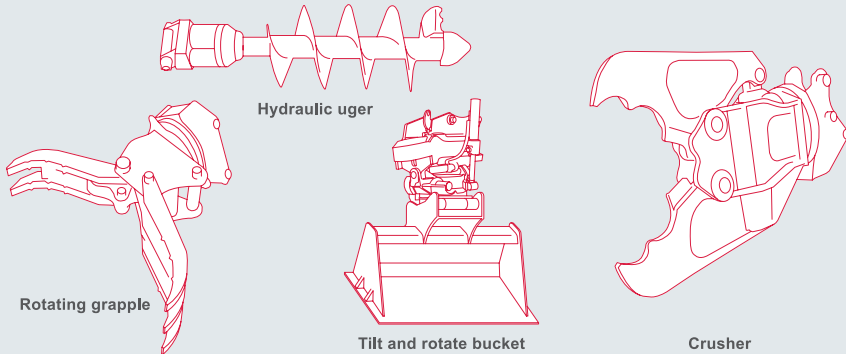

## ● Increased weight



## ● Pattern change valve (2 WAY / 4 WAY)



## ● Hydraulic quick coupler makes changing attachments quick and easy.



### ● Unattach bucket

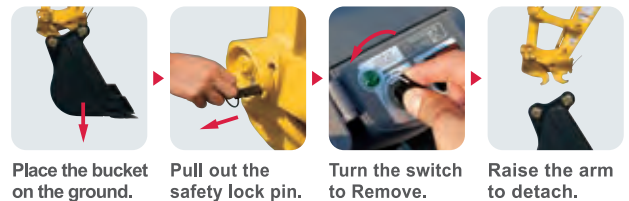

### ● Attach bucket

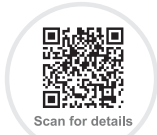
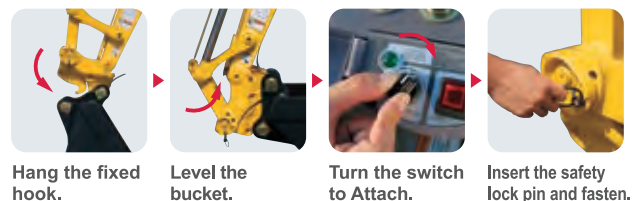

\* Pictures shown are for illustration purpose only. \* The images shown here are for promotional purposes.

\* The image may differ from the actual model on sale. \* The machine in the picture is equipped with optional parts. \* Ground the bucket when leaving the operator's seat.



# Providing services that keep you on track. SMARTASSIST Remote

\* Separate application required (free)



Scan for details

## ● Efficient use of machinery thanks to remote monitoring

Our construction equipment is equipped with GPS and communication terminals, allowing you to manage location information via the communication system. The system also lets YANMAR remotely monitor your machine, allowing us to keep on top of maintenance intervals, quickly identify machine trouble, and provide appropriate services and support at all times.

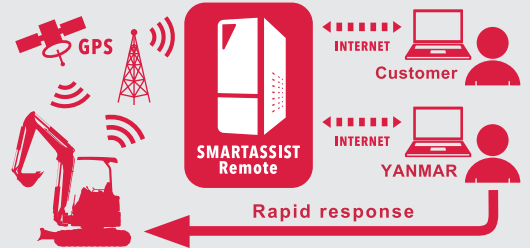

## ● Providing peace of mind, supporting your business

- Theft prevention tool**  
 The theft prevention feature emails you if the machine moves out of a pre-determined area.
- Error notification service**  
 Quickly identify location of error in the event of machine trouble.
- Maintenance management tool**  
 Manage inspection/ maintenance information.
- Operational status management tool**  
 Visualize operational status of machine.
- Work schedule creation tool**  
 Record work data and improve efficiency.

## The Unsung Heroes Who Build Our Towns And Cities

You build the infrastructure and the foundations in our towns and cities.  
Transforming the places where we stand today, into dreams of tomorrow.  
You are the unsung hero.

The YANMAR mission is to provide machines and services that allow you to reach your full potential.

Built tough and with comfort in mind,  
YANMAR construction equipment will help you get the job done with ease, regardless of the worksite.  
When we make machines, we are dedicated to enabling you to perform at your best all of the time.

One example of this is our innovative True Zero Tail Swing Excavators that set the standard for safety and reliability, enabling operators to perform at their best in tight quarters.

YANMAR also manufactured the first compact diesel engines  
and today we continue to make diesel engines ranging from 4 to 4,800 kW.

Equipped with advanced engines and hydraulic systems, our construction equipment delivers better fuel economy, increased productivity and enhanced operation.

**YANMAR is the driving force behind the unsung hero.**

# BEST PERFORMANCE BY YOUR SIDE

# Lifting Capacity

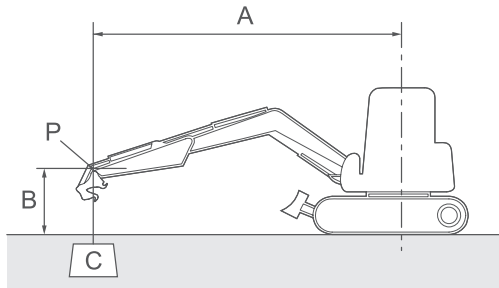

With;  
Cabin  
Rubber Crawler  
Quick coupler spec.  
Without Bucket

A: Reach from swing center line [m<in.>]

B: Load point height [m<in.>]

C: Lifting load [kg<lbs.>]

P: Load point

: Rating over front

: Rating over side or 180 degrees

Blade on ground

Unit : kg (lbs.)

A [m<in.>]	Max.		5.0<196.9>		4.0<157.5>		3.0<118.1>	
B [m<in.>]								
5.0<196.9>	1780 <*3925>	1430 <3153>	-	-	-	-	-	-
4.0<157.5>	1790 <*3947>	1190 <2624>	1710 <*3771>	1710 <*3771>	1740 <*3837>	1780 <*3925>	-	-
3.0<118.1>	1780 <*3925>	1030 <2271>	1780 <*3925>	1440 <3175>	2050 <*4520>	2050 <*4520>	-	-
2.0<78.7>	1790 <*3947>	950 <2095>	2080 <*4586>	1370 <3021>	2480 <*5468>	1980 <4366>	-	-
1.0<39.4>	1880 <*4145>	920 <2029>	2270 <*5005>	1330 <2933>	3090 <*6813>	1850 <4079>	4530 <*9989>	2680 <5909>
0<0>	1850 <*4079>	1000 <2205>	2490 <*5490>	1310 <2889>	3210 <*7078>	1820 <4013>	4550 <*10033>	2710 <5976>
-1.0<-39.4>	1880 <*4145>	1110 <2448>	2370 <*5226>	1260 <2778>	3110 <*6858>	1730 <3815>	4270 <*9415>	2710 <5976>
-2.0<-78.7>	1840 <*4057>	1330 <2933>	-	-	2660 <*5865>	1770 <3903>	3720 <*8203>	2720 <5998>

Blade above ground

Unit : kg (lbs.)

A [m<in.>]	Max.		5.0<196.9>		4.0<157.5>		3.0<118.1>	
B [m<in.>]								
5.0<196.9>	1780 <*3925>	1430 <3153>	-	-	-	-	-	-
4.0<157.5>	1400 <3087>	1160 <2558>	1710 <*3771>	1710 <*3771>	1740 <*3837>	1780 <*3925>	-	-
3.0<118.1>	1200 <2646>	990 <2183>	1780 <*3925>	1430 <3153>	2050 <*4520>	2050 <*4520>	-	-
2.0<78.7>	1130 <2492>	920 <2029>	1640 <3616>	1320 <2911>	2480 <*5468>	1930 <4256>	-	-
1.0<39.4>	1180 <2602>	900 <1985>	1570 <3462>	1280 <2822>	2270 <5005>	1850 <4079>	3350 <7387>	2640 <5821>
0<0>	1220 <2690>	990 <2183>	1550 <3418>	1250 <2756>	2150 <4741>	1760 <3881>	3290 <7254>	2630 <5799>
-1.0<-39.4>	1310 <2889>	1040 <2293>	1520 <3352>	1240 <2734>	2110 <4653>	1690 <3726>	3320 <7321>	2600 <5733>
-2.0<-78.7>	1550 <3418>	1320 <2911>	-	-	2140 <4719>	1720 <3793>	3210 <7078>	2670 <5887>

Note :

The lifting load with the asterisk (\*) mark is limited by hydraulic lifting capacity rather than tipping. The lifting capacity shown in the above list is based on the ISO Standard No. 10567 and represents either 87 % of hydraulic lifting capacity or 75 % of tipping load, which is smaller.

● Dimensions

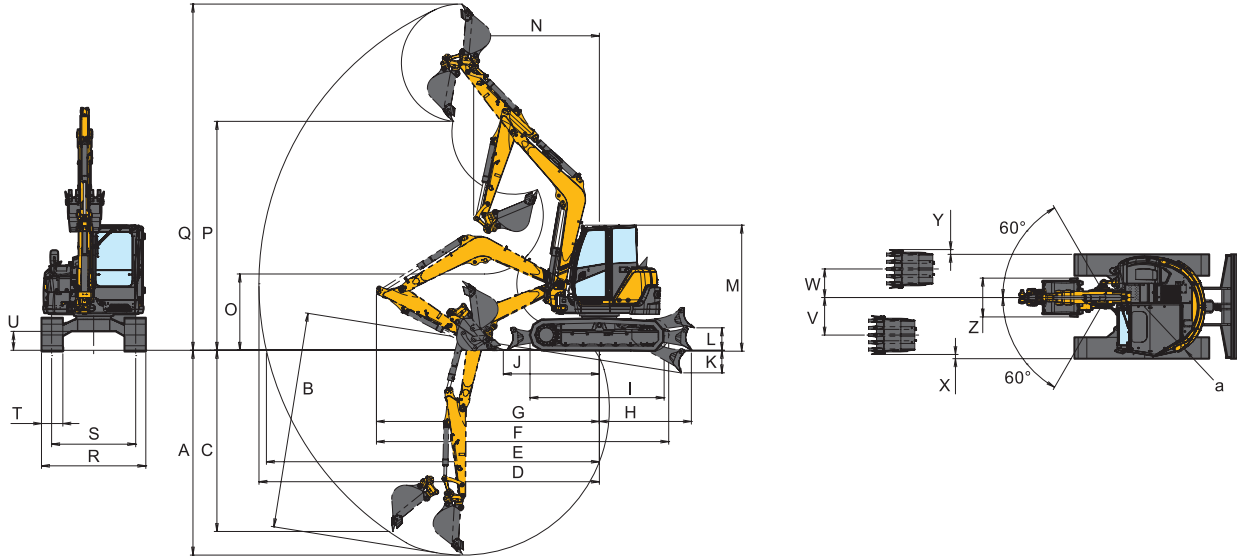

Unit: mm <ft-in>

	A	B	C	D	E	F	G	H	I	J	K	L	M	N	O	P	Q	R	S	T	U	V	W	X	Y	Z	a	
Quick coupler	4530 <14'10">	4810 <15'9">	4010 <13'2">	7570 <24'10">	7400 <24'3">	6490 <21'4">	4950 <16'3">	2040 <6'8">	3070 <10'1">	2230 <7'4">	460 <1'6">	520 <1'8">	2810 <9'3">	2790<9'2"> R2390<7'10">at boom swing	1730 <5'8">	5120 <16'10">	7730 <25'4">	2320 <7'7">	1870 <6'2">	485 <1'7">	450 <1'6">	835 <2'9">	105 <4">	95 <4">	105 <4">	850 <2'9">	1330 <52.5">	
without Quick coupler	4290 <14'1">	4570 <14'12">	3870 <12'8">	7240 <23'9">	7060 <23'2">	6390 <20'12">				2020 <6'8">				2480<8'2"> R2110<6'11">at boom swing	1880 <6'2">	5410 <17'9">	7260 <23'10">											

Specifications

Model		SV100-2B				
Spec		Cab. rubber crawler		Cab. steel crawler		
Type		Quick coupler	without Quick coupler	Quick coupler	without Quick coupler	
Operating Weight		kg<lbs>	9775<21550>	9625<21219>	9825<21660>	9675<21330>
Engine	Type	Turbo charged vertical 4 cylinder, water-cooled direct inject diesel				
	Model	4TNV98T-ZSBV2				
	Rated Output (Gross)	kW<hp>/min <sup>-1</sup>	54.7<73.3>/2200[Gross]			
Performance	Bucket capacity, standard (ISO heaped)	cu.m<cu.ft>	0.30<10.59>			
	Max Digging Force	kN<lbf>	54.3<12207>/42.3<9509>	68.5<15399>/45.8<10296>	54.3<12207>/42.3<9509>	68.5<15399>/45.8<10296>
	Traveling Speed, High/Low	km/h<MPH>	4.4<2.7>/2.5<1.6>		4.0<2.5>/2.2<1.4>	
	Swing Speed	rpm	9.1			
	Boom Swing Angle, (L / R)	degrees	60/60			
	Gradability	degrees	30			
Ground Contact Pressure		kPa<PSI>	37.9<5.5>		38.8<5.6>	
Hydraulic System	Pump Capacity	L/min<GPM>	77.7<20.5>×2 (Variable displacement pump)			57.5<15.2>×1, 20<5.3>×1 (Gear pump)
	Main Relief Set Pressure	MPa<PSI>	27.5×2, 24.0×1, 2.9×1<3988×2, 3481×1, 421×1>			
Blade	Width	mm<ft-in>	2320<7'7">			
Dimensions	Stroke, Raise / Lower from G.L.	mm<ft-in>	520<1'8"> / 460<1'6">		495<1'7"> / 485<1'7">	
Fuel tank capacity		L	115			

Hydraulic P.T.O.

Model		SV100-2B		
Output		MPa<PSI>	L/min<GPM>	
Specification				2000RPM
Combined Flow, Double Actions		27.5<3988>	130<34.3>	75<19.8>

All data subject to change without notice.